











SurroundVUE™ 360° System

FLTW-3601



Recommended Tools				Difficulty Level
 Wire Strippers	 Wire Cutters	 Electrical Tape	 Drill	
 Screw Driver	 Panel Removal Tool	 Zip Ties	 1/4" Drill Bit	Install Time
<p>Questions? Call the Brandmotion technical support line at (734) 619-1250 or CLICK HERE</p>				 6hr - 8hr 30m

Kit Contents



1x 360 Monitor (A)
1x 360 Main Harness (B)
1x Dial Receiver (C)
1x USB Port (D)
7x Camera Cable Extensions (E)
4x Cameras (F)
1x Monitor Housing (G)
1x Rotary Dial (H)

1x Coin Cell Battery (I)
1x Fan Mount (J)
4x Camera Gaskets (K)
4x Camera Wedges (L)
1x Misc Install Supplies

Setting up 360° System

Part 1

360 System Overview

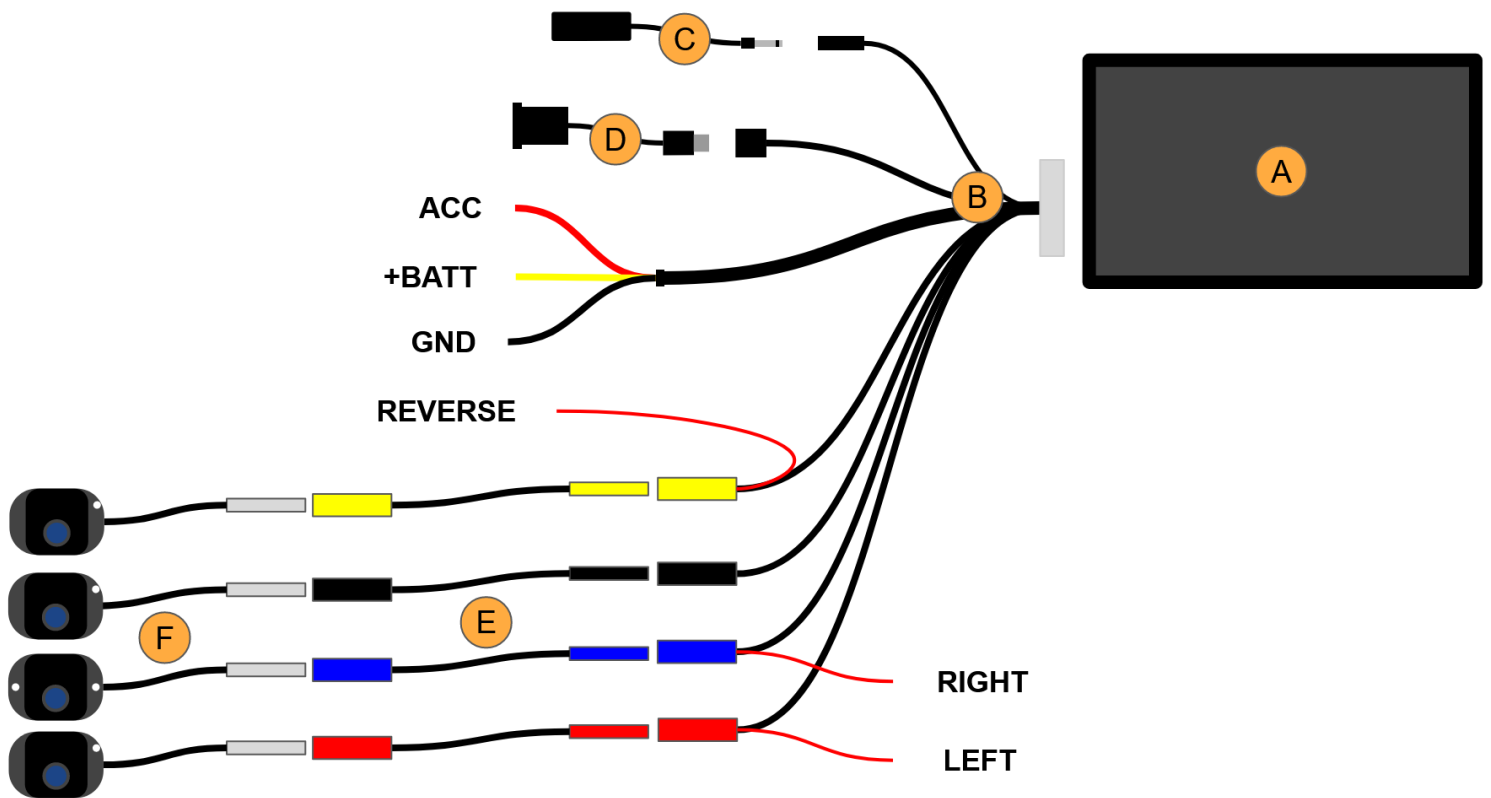

- The above figure shows the layout of all electrical components in the kit.
- These labels do not correspond to tags on the components in the kit.
- Wire lengths are scaled to fit page

A	360 Monitor
B	360 Main Harness
C	Dial Receiver
D	USB Port
E	Camera Cable Extensions
F	Cameras

Installing Hardware

Part 1

Mounting Cameras

1. Determine locations for the four cameras.
 - Front Camera: Top of the grille
 - Left & Right Camera: Top of the vehicle at the length midpoint
 - Rear Camera: Top center of the vehicle

2. Drill 1/4" hole in the vehicle at each camera location to run the wire into the vehicle.

NOTE: Before you drill any holes into the vehicle, check to see if the camera locations have any harnesses or brackets in the way.

3. Pass the camera wire through the center of the gasket and fit the gasket around the camera base.

NOTE: The kit includes an optional camera spacer wedge in case the vehicle geometry requires it.

4. Run the camera wire through the drilled hole in the vehicle body.
5. Mark and pre-drill the holes for the screws to attach the camera to the vehicle body.
6. Drive screws through the camera body into the mounting surface.

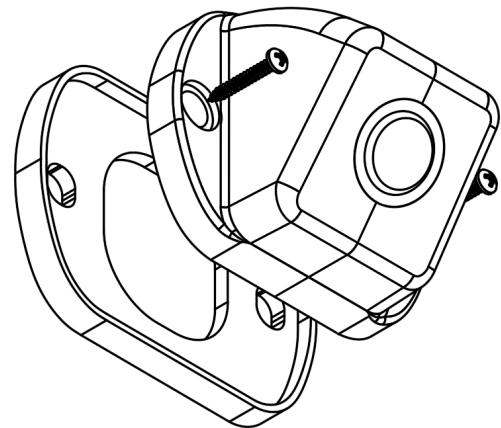
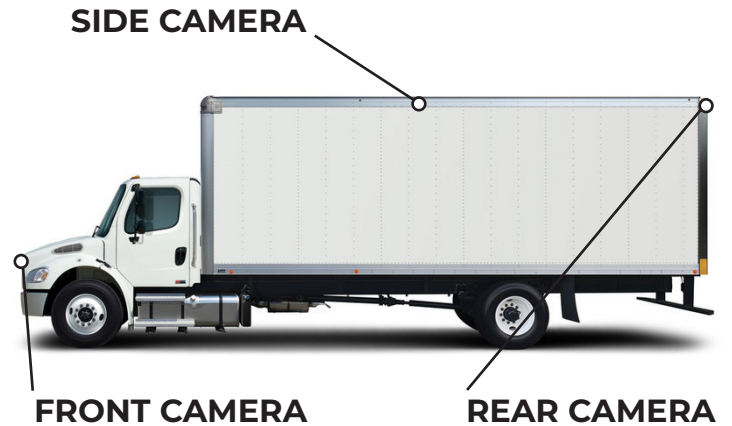

Part 2

Signal Wires (Left Turn, Right Turn and Reverse)

1. According to your specific vehicle, locate and tap into the reverse, left, and right turn signal wires.
2. Run leads up to where the system will be installed.
3. On the 360 Main Harness, tie the red wire coming off of the yellow camera connector to reverse, the red wire from the blue connector to the right turn signal wire, and the red wire from the red camera connector to left turn signal.
4. Temporarily plug the white main harness connector into the 360 system and test to make sure the system comes on when the key is turned. Verify that reverse and turn signals trigger their respective views.

Note: On some vehicles, the rear turn signal wires may also be used for brake lights. If this is the case, use the front turn signal wire.

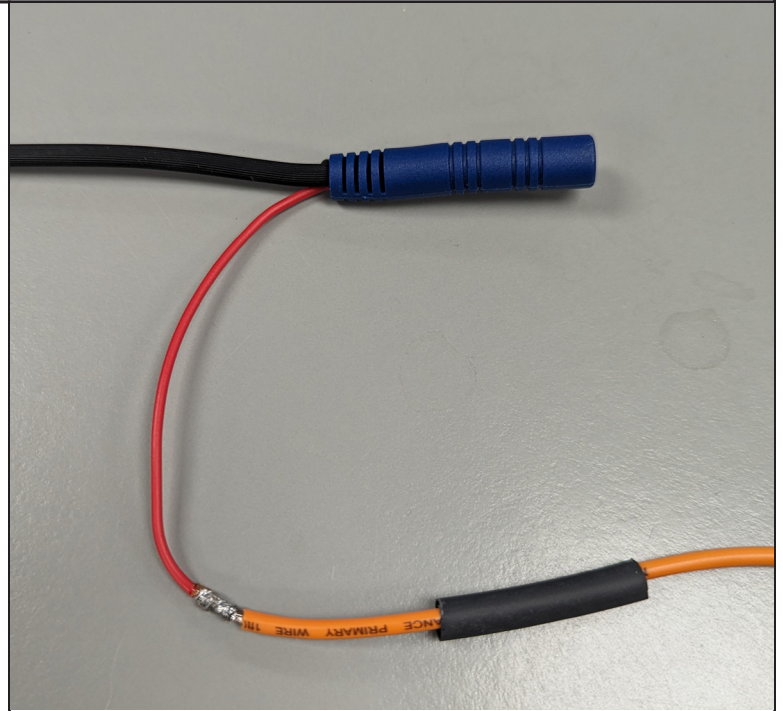

Running Cables

Part 1

Running Wires

1. Run the camera color matched extension cables through the vehicle to each camera from the 360 main harness location.
2. Connect each camera extension to 360 main harness according to color.
3. (Optional) install the USB port somewhere accessible and plug the USB into the main harness.
4. Plug the dial receiver into the main harness.

Red	Left Camera
Blue	Right Camera
Yellow	Rear Camera
Black	Front Camera

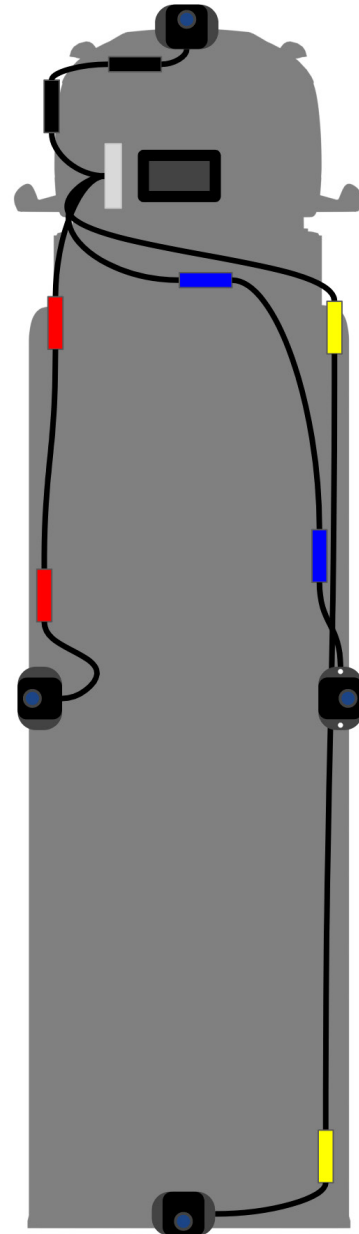

Mounting the System

Part 1

Putting the System in the Housing

1. On the 360 system housing, remove the wire cover plate from the back.
2. Pass the 360 main harness through the opening, with the white connector towards the inside of the housing.
3. Plug the white connector into the 360 system.
4. Snap the cover plate back over the hole.
5. Snap the 360 system into the housing and screw it in from the back with screws.



Part 2

Mounting the Housing in the Vehicle

1. Choose a desired mounting location on the dashboard to mount the fan mount on.
2. Peel off the red 3M tape cover and adhere it to the dash, then use provided screws to secure the mount more permanently.
3. Slide the monitor in between the bracket on the mount.
4. Tighten the retaining nut against the bracket to secure monitor in place.

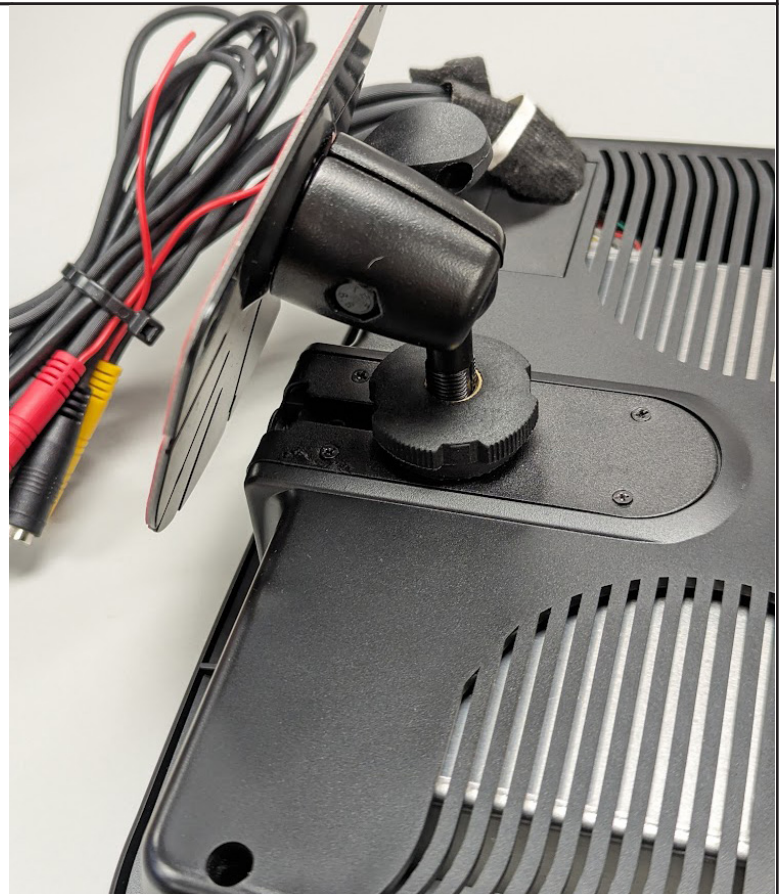

Part 3

Mounting Dial Controller

1. Slide the battery cover off of the dial and install the provided coin cell battery.
2. Slide the cover back on.
3. Clean the mounting location surface with isopropyl alcohol and remove red 3M tape cover.
4. Mount the dial wherever is preferred by the driver. Press firmly to adhere.

Note: The knob battery cover slides off, ensure the mounting orientation is such that the knob slides down onto the cover.



Calibration

Part 1

Preparing for Calibration

1. Create calibration mats by cutting four 5' x 5' squares in a color that contrasts the floor. (Cardboard or tarp are recommended)
2. Place a square in each corner of the vehicle about 2' from front and back and 11' apart.
3. It is required to have the mats lay flat during the calibration process to ensure an accurate reading.
4. The mats can be adjusted as needed in later steps.
5. It is important that the mats are in line and parallel with the vehicle.

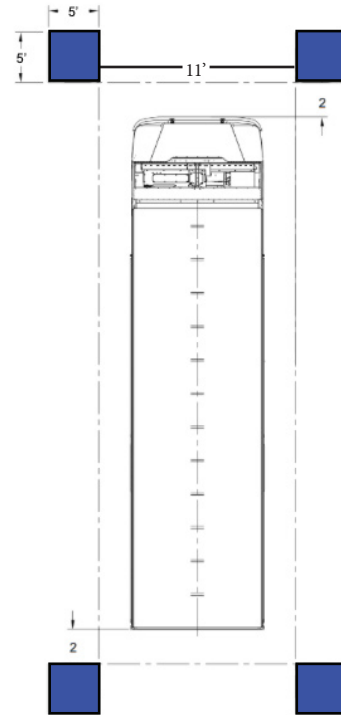

Part 2

Calibration Setup

1. Tap on the rightmost arrow icon to show the gear icon.
2. Tap the gear to enter settings.
3. If applicable, the passcode is 8899.
4. On the calibration line, tap edit.

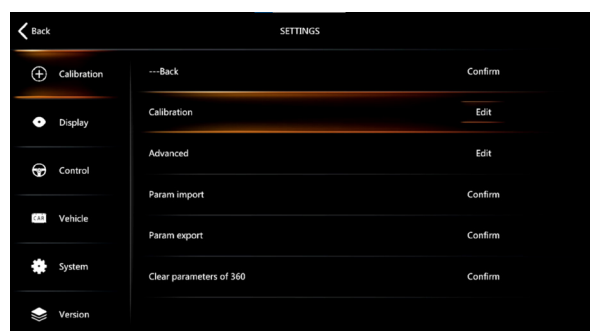
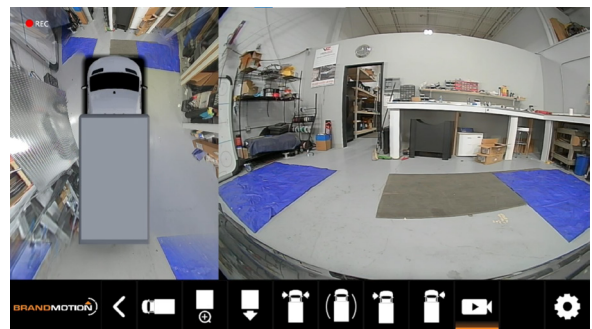

Part 3

Calibration Setup

5. Tap the left option showing the four squares in the corners of the vehicle.
6. Make sure you can clearly see all four corners of the squares for both squares in each camera.
7. If you cannot see all the corners, move the square until you can see them.
8. Tap [Continue] when all squares are clearly visible.

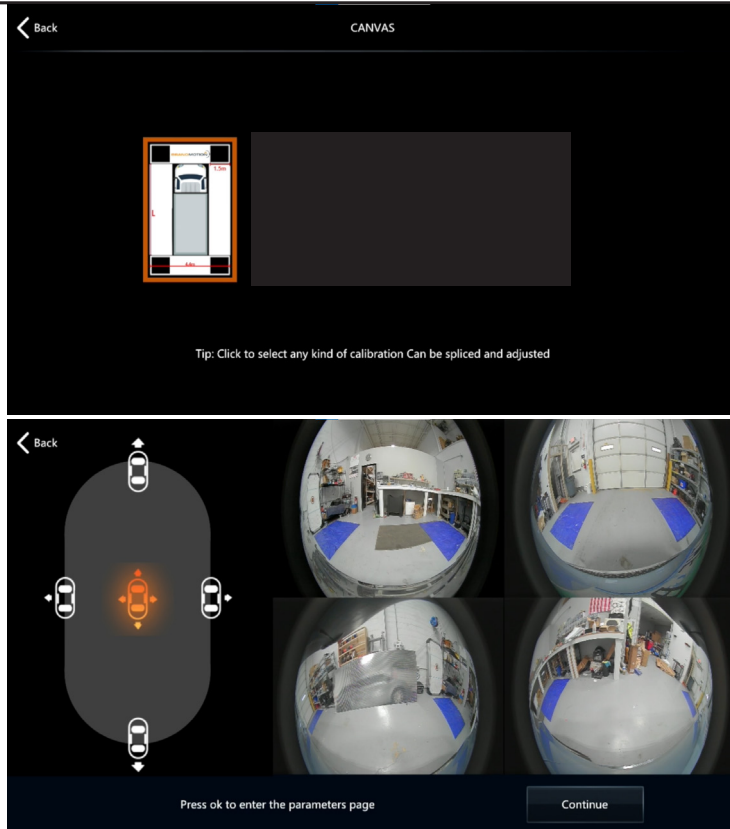

Part 4

Vehicle Dimensions

1. Measure the vehicle length and width in cm. Enter those values into the appropriate boxes. If the length greater than 610 centimeters, divide the length and width by 1.5 and enter those values. ($\text{Length} \div 1.5 = \text{New Value}$) and ($\text{Width} \div 1.5 = \text{New Value}$)
2. Make sure L-S type is set to [6048-2053-1080p]
3. Tap [Calibration]
4. You will now see a loading indicator for 20 seconds or less
5. The system will try to automatically find the squares. It may fail if there is not enough contrast or the background is too busy. This is okay, you can manually correct it. [Tap OK]



Part 5

Image Adjustments

- Drag each + to the corners of the squares, making sure you follow the pattern:

Upper Left, Upper Right, Lower Left, and Lower Right.
- Repeat for each of the squares on screen to improve calibration.



Part 6

Image Adjustments (Optional)

- You may see some distortion of straight lines along the left and right side of the vehicle.
- Tap [Advance]
- Tap on the side of the vehicle you would like to modify (left shown above)
- Adjust the Vertical Centerpoint until the lines straighten out.
- Do this for left and right sides.
- To straighten the front, tap on the front of the truck and adjust L-gap and R-gap to align.
- The same can be done for the rear.
- When you have a calibration you are satisfied with, tap [Save Quit]
- Tap [Ok]
- The system has been calibrated.

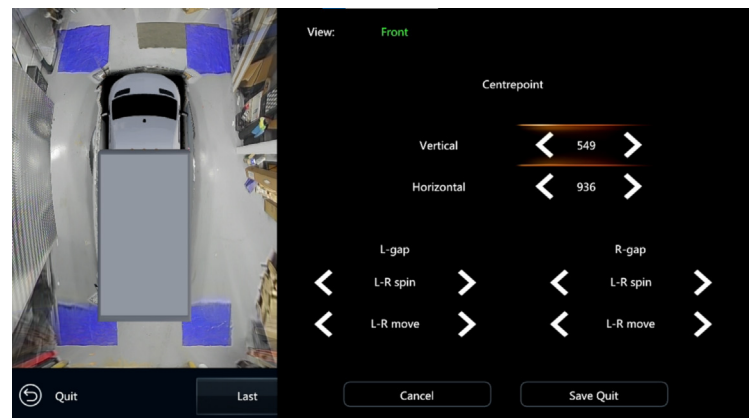

Part 7

Image Adjustments (Optional)

1. If the vehicle model is taking up too much screen space, go the settings and navigate to [Display] -> [View Setup].
2. Tap on [F-origin] and scroll down to [R-full view]
3. The panel will move to the right side of the screen and reveal the truck on the left.
4. Tap on [Scale] then tap the left and right arrows surrounding [Whole] to scale the view up or down.
5. Tap [Ok] to exit.
6. Do the same for [L-full view] if needed.

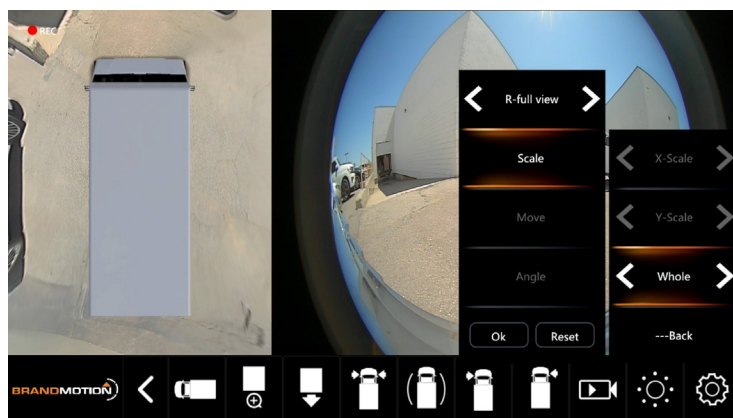
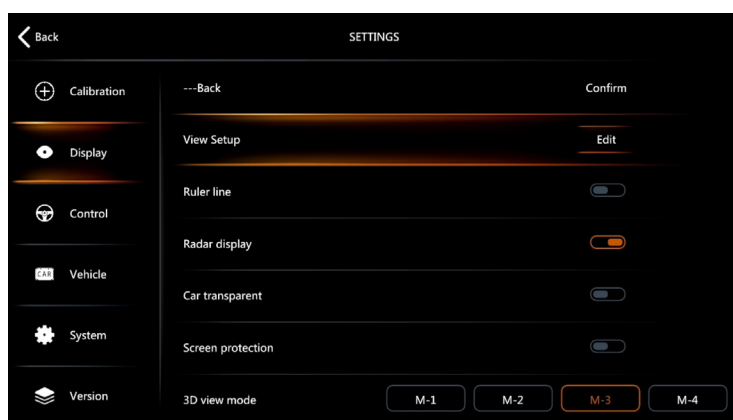

Customizing the System

Part 1

Setting the Vehicle Model

1. In the settings go to [Vehicle] -> [Car model] -> [Edit]
2. Tap [Model] and select the vehicle type that best matches the installed vehicle
3. Choose desired Trace (NULL recommended)
4. Choose the Color that best matches the installed vehicle.
5. Adjust the Length and Width as desired.

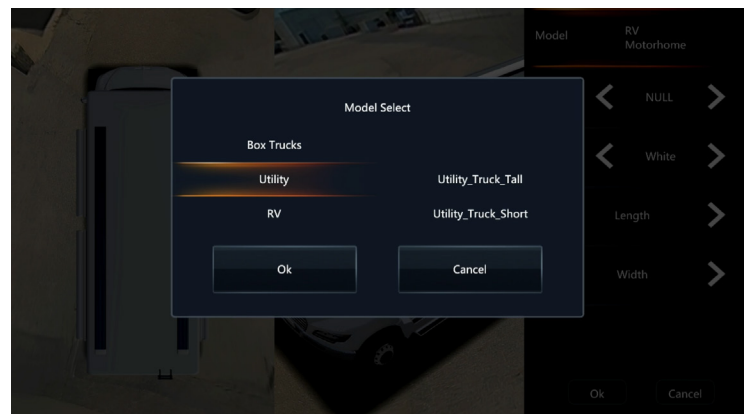
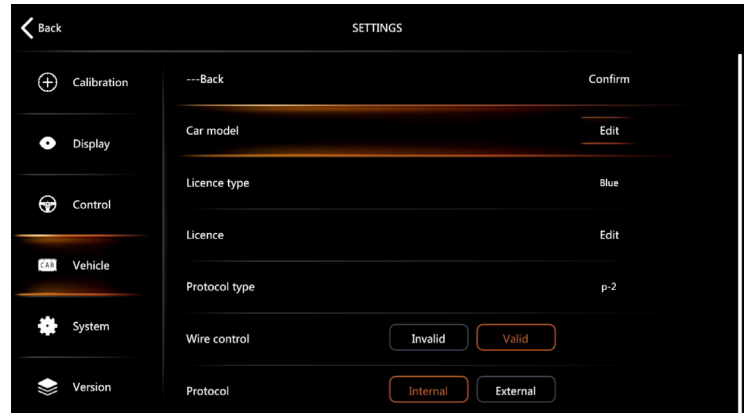

Part 2

Backup Camera Settings

1. There are two modes for the backup camera, full camera view and calibrated view.
2. In the settings go to [Control] -> [Front/Rear Adjusting].
3. If you want the full backup camera unmodified view, toggle [Front/Rear Adjusting] Off.

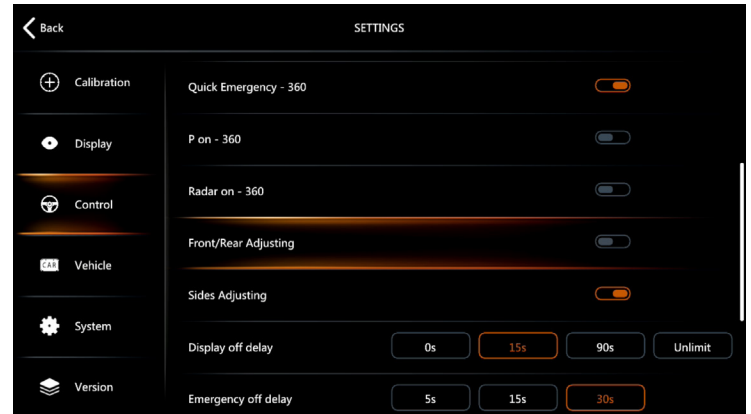

Part 3

Parking Monitor

1. Set the desired parking monitor duration to record after the system shuts down.
 - The system will record for this duration or until it reaches the voltage threshold.
2. Set the voltage threshold to something lower than the real-time voltage reads when the vehicle is not running.
 - The system will stop recording and shut down completely when the battery reaches this threshold to prevent battery drain.

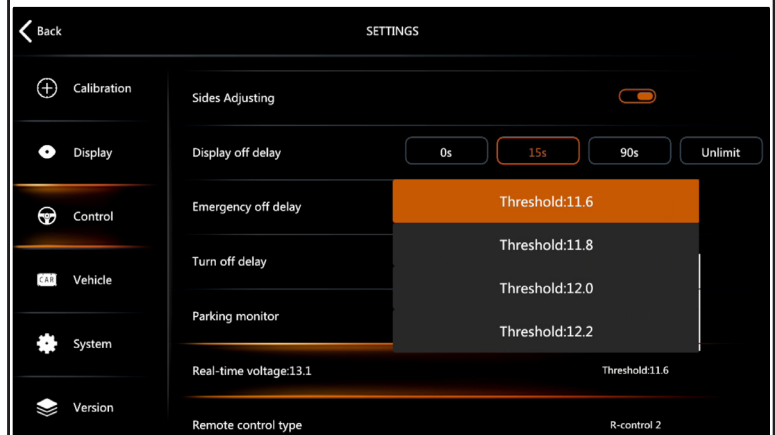
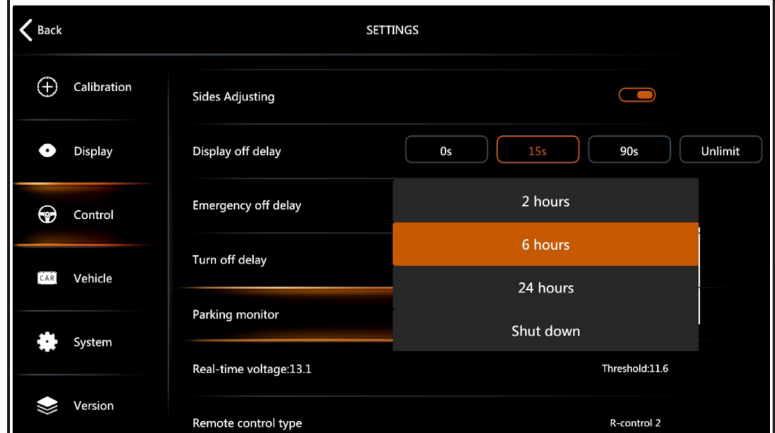

Part 3

Settings Dictionary

Calibration

- Calibration - Enter calibration settings
- Advanced - Advanced fine tuning calibration settings
- Param import - Import calibration parameter preset from USB
- Param export - Export calibration parameters to USB
- Clear parameters of 360 - Clear calibration settings

Display

- View Setup - Set up camera views
- Ruler line - Backup camera line
- Radar display - (not applicable)
- Car transparent - Enables ability to set car model transparent / invisible (Tap topdown vehicle model)
- Screen protection - Screen timeout (don't change)
- 3D view mode - 3D turn signal perspective
- Screen setting - Top down 360 view Left or Right side
- Resolution - Screen type (don't change)
- Camera Type - Camera resolution (don't change)
- Logo import - (not applicable)

Control

- Power on and look around - duration of 3D spinning when powered on
- Signal Turn - 360 - Enable turn signal views
- Signal Turn - 3D view - Toggle between 2D or 3D turn signal mode
- Look back when turn signal - (not applicable)
- Quick Emergency 360 - (not applicable)
- P on -360 - (not applicable)
- Radar on -360 - (not applicable)
- Front/Rear Adjusting - Modes for backup camera
- Sides Adjusting - Calibrated/uncalibrated 2D side camera views
- Display off delay - (not applicable)
- Emergency off delay - (not applicable)
- Turn off delay - Accessory shutoff delay
- Parking monitor - Record duration after shutoff
- Real-time voltage - Threshold to shut off parking monitor recording to not drain battery

Vehicle

- Car model - Change vehicle image
- License type - License plate color
- License - License plate number
- Wire control - Turn signal/backup trigger wires enable
- Protocol - (Not applicable)

System

- 2020/01/01 - Set date
- 00:30 - Set time
- Screen adjustment - Crop / move screen
- Touch correction - Touch screen calibration
- Language setting - Change language
- USB formatting - Format USB device
- System upgrade - USB system update
- Recording path - Record to System/USB
- Decoder upgrade - (not applicable)